

STIHL



2 - 21 Instruction Manual



Contents

1	Guide to Using this Manual.....	2
2	Safety Precautions and Working Techniques.....	2
3	Assembling the Unit.....	6
4	Adjusting the Throttle Cable.....	8
5	Fitting the Harness.....	9
6	Fuel.....	10
7	Fueling.....	11
8	Winter Operation.....	11
9	Information Before You Start.....	12
10	Starting / Stopping the Engine.....	12
11	Operating Instructions.....	15
12	Replacing the Air Filter.....	15
13	Adjusting the Carburetor.....	15
14	Spark Plug.....	15
15	Spark Arresting Screen in Muffler.....	16
16	Storing the Machine.....	17
17	Inspections and Maintenance by Dealer.....	17
18	Maintenance and Care.....	17
19	Main Parts.....	19
20	Specifications.....	19
21	Maintenance and Repairs.....	20
22	Disposal.....	20
23	EC Declaration of Conformity.....	21

1 Guide to Using this Manual

1.1 Pictograms

The meanings of the pictograms attached to the machine are explained in this manual.

Depending on the model concerned, the following pictograms may be attached to your machine.



Fuel tank; fuel mixture of gasoline and engine oil



Intake air: Winter operation



Intake air: Summer operation



Operate manual fuel pump

1.2 Symbols in text



WARNING

Warning where there is a risk of an accident or personal injury or serious damage to property.

NOTICE

Caution where there is a risk of damaging the machine or its individual components.

1.3 Engineering improvements

STIHL's philosophy is to continually improve all of its products. For this reason we may modify the design, engineering and appearance of our products periodically.

Therefore, some changes, modifications and improvements may not be covered in this manual.

2 Safety Precautions and Working Techniques



Special safety precautions must be observed when working with a power tool.



It is important that you read the instruction manual before first use and keep it in a safe place for future reference. Non-observance of the instruction manual may result in serious or even fatal injury.

Observe all applicable local safety regulations, standards and ordinances.

If you have not used this model before: Have your dealer or other experienced user show you how it is operated or attend a special course in its operation.

Minors should never be allowed to use this product.

Keep bystanders, especially children, and animals away from the work area.

When the power tool is not in use, put it in a place where it does not endanger others. Secure it against unauthorized use.

The user is responsible for avoiding injury to third parties or damage to their property.

Do not lend or rent your power tool without the instruction manual. Be sure that anyone using your power tool understands the information contained in this manual.

The use of noise emitting power tools may be restricted to certain times by national or local regulations.

Do not operate your power tool if any of its components are damaged.

Do not use a pressure washer to clean your power tool. The solid jet of water may damage parts of the power tool.

2.1 Accessories and replacement parts

Only use parts and accessories that are explicitly approved for this power tool by STIHL or are technically identical. If you have any questions in this respect, consult a servicing dealer. Use only high quality parts and accessories in order to avoid the risk of accidents and damage to the machine.

STIHL recommends the use of original STIHL replacement parts and accessories. They are specifically designed to match the product and meet your performance requirements.

Never attempt to modify your machine in any way since this may increase the risk of personal injury. STIHL excludes all liability for personal injury and damage to property caused while using unauthorized attachments.

2.2 Physical Condition

To operate this power tool you must be rested, in good physical condition and mental health.

If you have any condition that might be aggravated by strenuous work, check with your doctor before operating a power tool.

Persons with pacemakers only: The ignition system of your power tool produces an electromagnetic field of a very low intensity. This field may interfere with some pacemakers. To reduce health risks, STIHL recommends that persons with pacemakers consult their physician and the pacemaker manufacturer before operating this power tool.

Do not operate the sprayer if you are under the influence of any substance (drugs, alcohol) which might impair vision, dexterity or judgment.

2.3 Intended Use

The blower is designed for blow-sweeping leaves, grass, paper and similar materials, e.g. in gardens, sports stadiums, car parks and drive-

ways. It is also suitable for blow-sweeping forest paths.

Do not blow-sweep hazardous materials.

Do not use the machine for any other purpose because of the increased risk of accidents and damage to the machine. Never attempt to modify the product in any way since this may result in accidents or damage to the product.

2.4 Clothing and Equipment

Wear proper protective clothing and equipment.



Clothing must be sturdy but allow complete freedom of movement. Wear snug-fitting clothing, an overall and jacket combination, do not wear a work coat.



Avoid clothing with loose drawstrings, laces and ribbons, scarves, neckties, jewelry or anything that could be sucked into the air intake in the side and bottom of the machine. Tie up and confine long hair so that it cannot be sucked into the machine.

Wear sturdy shoes with non-slip soles.



WARNING



To reduce the risk of eye injuries, wear close-fitting safety glasses in accordance with European Standard EN 166. Make sure the safety glasses are a comfortable and snug fit.

Wear hearing protection, e.g. earplugs or ear muffs.

STIHL offers a comprehensive range of personal protective clothing and equipment.

2.5 Transporting the Power Tool

Always shut off the engine.

Transporting in a vehicle:

- Properly secure your power tool to prevent turnover, fuel spillage and damage.

2.6 Fueling



Gasoline is an extremely flammable fuel. Keep clear of naked flames. Do not spill any fuel – do not smoke.

Always **shut off the engine** before refueling.

Do not fuel a hot engine – fuel may spill and **cause a fire**.

Always remove the power tool from your back and put it on the ground before refueling. Fuel the machine only when it is standing on the ground.

Open the fuel cap carefully to allow any pressure build-up in the tank to release slowly and avoid fuel spillage.

Fuel your power tool only in well-ventilated areas. If you spill fuel, wipe the machine immediately – if fuel gets on your clothing, change immediately.



Check for leakage. To reduce the **risk of serious or fatal burn injuries**, do not start or run the engine until leak is fixed.

Screw-type fuel cap



After fueling, tighten down the screw-type fuel cap as securely as possible.

This reduces the risk of unit vibrations causing the fuel cap to loosen or come off and spill quantities of fuel.

2.7 Before Starting

Check that your power tool is properly assembled and in good condition – refer to appropriate chapters in the instruction manual.

- Check the fuel system for leaks, paying special attention to visible parts such as the tank cap, hose connections and the manual fuel pump (on machines so equipped). If there are any leaks or damage, do not start the engine – **risk of fire**. Have your machine repaired by a servicing dealer before using it again.
- Throttle trigger must move freely and spring back to the idle position when released.
- The setting lever must move easily to **STOP** or **0**
- The blower tubes must be properly assembled.
- Keep the handles dry and clean – free from oil and dirt – for safe control of the power tool.
- Check that the spark plug boot is secure – a loose boot may cause arcing that could ignite leaking fuel-air mixture **and cause a fire**.
- Never attempt to modify the controls or the safety devices in any way.
- Check condition of blower housing.
- Check condition of harness straps and backpack – replace damaged or worn straps.

A worn blower housing (cracks, nicks, chips) may result in an increased risk of injury from

thrown foreign objects. If the blower housing is damaged, consult your dealer – STIHL recommends you contact a STIHL servicing dealer.

To reduce the risk of accidents, do not operate your power tool if it is not in a safe condition.

For emergencies: Practice quickly opening the fastener on the waist belt, loosening the shoulder straps and setting down the unit.

2.8 Start the engine.

Start the engine at least 3 meters from the fueling spot, outdoors only.

Your power tool is designed to be operated by one person only. Do not allow other persons in the work area – even when starting.

Do not drop start the power tool – start the engine as described in the instruction manual.

Place the power tool on level ground, make sure you have secure footing, hold the power tool securely.

As soon as the engine starts, the air flow may throw small objects (e.g. stones) in your direction.

2.9 During Operation

In the event of impending danger or in an emergency, switch off the engine immediately by moving the setting lever to **STOP** or **0**.



To reduce the risk of injury from thrown objects, do not allow any other persons within 15 meters of your own position.

To reduce the risk of damage to property, also maintain this distance from other objects (vehicles, windows).



Do not direct the air blast towards bystanders or animals since the air flow can blow small objects at great speed – **risk of injury**.

When blow-sweeping (in open ground and gardens), watch out for small animals to avoid harming them.

Never leave a running machine unattended.

Take special care in slippery conditions – damp, snow, ice, on slopes and uneven ground.

Watch out for obstacles: Be careful of refuse, tree stumps, roots and ditches which could **cause you to trip or stumble**.

Never work on a ladder or any other insecure support.

Be particularly alert and cautious when wearing hearing protection because your ability to hear warnings (shouts, alarms, etc.) is restricted.

Work calmly and carefully – in daylight conditions and only when visibility is good. Stay alert so as not to endanger others.

To reduce the risk of accidents, take a break in good time to avoid tiredness or exhaustion.



Your power tool produces **toxic exhaust fumes** as soon as the engine is running. These fumes may be colorless and odorless and contain unburned hydrocarbons and benzol. Never run the engine indoors or in poorly ventilated locations, even if your model is equipped with a catalytic converter.

To reduce the risk of serious or fatal injury from breathing toxic fumes, ensure proper ventilation when working in trenches, hollows or other confined locations.

To reduce the risk of accidents, stop work immediately in the event of nausea, headache, visual disturbances (e.g. reduced field of vision), problems with hearing, dizziness, deterioration in ability to concentrate. Apart from other possibilities, these symptoms may be caused by an excessively high concentration of exhaust gases in the work area.

To reduce the risk of fire, do not smoke while operating or standing near your power tool. Note that combustible fuel vapor may escape from the fuel system.

If dust levels are very high, always wear a suitable respirator.

Operate your power tool so that it produces a minimum of noise and emissions – do not run the engine unnecessarily, accelerate the engine only when working.

After finishing work, put the unit down on a level, non-flammable surface. **To reduce the risk of fire**, do not put it down near easily combustible materials (e.g. wood chips, bark, dry grass, fuel).

If your power tool is subjected to unusually high loads for which it was not designed (e.g. heavy impact or a fall), always check that it is in good condition before continuing work – see also "Before Starting Work". Check the fuel system in particular for leaks and make sure the safety devices are working properly. Do not continue

operating your power tool if it is damaged. In case of doubt, consult your servicing dealer.

2.10 Using the Blower

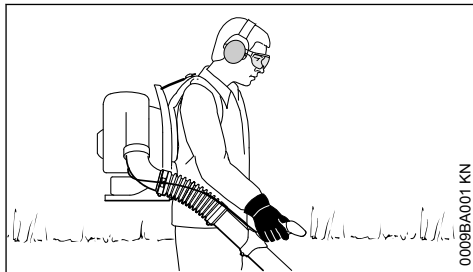

The machine is carried as a backpack. Hold and control the blower tube with your right hand on the control handle.

Walk slowly forwards as you work – observe the nozzle outlet at all times – do not walk backwards – **risk of stumbling**.

Always shut off the engine before taking the machine off your back.

2.11 Working Technique

To minimize blowing time, use a rake and broom to loosen dirt particles before you start blowing.

- If necessary, dampen the surface to be cleaned in order to avoid creating too much dust.
- Do not blow particles in the direction of bystanders, in particular in the direction of children, pets, open windows or freshly washed vehicles. Take special care in such situations.
- Remove the blow-swept debris in rubbish bins – do not blow it onto the neighbor's land.
- Operate your power tool at reasonable times only – not early in the morning, late at night or during midday rest periods when people could be disturbed. Observe local rest periods.
- Operate blowers at the lowest engine speed necessary to accomplish the task.
- Check your blower before starting work. Pay special attention to the muffler, air intakes and air filter.

2.12 Vibrations

Prolonged use of the power tool may result in vibration-induced circulation problems in the hands (whitefinger disease).

No general recommendation can be given for the length of usage because it depends on several factors.

The period of usage is prolonged by:

- Keeping your hands warm
- Work breaks

The period of usage is shortened by:

- Any personal tendency to suffer from poor circulation (symptoms: frequently cold fingers, itching).
- Low outside temperatures.
- Gripping force (a tight grip hinders circulation).

Continual and regular users should monitor closely the condition of their hands and fingers. If any of the above symptoms appear (e.g. tingling sensation in fingers), seek medical advice.

2.13 Maintenance and Repairs

Service the machine regularly. Do not attempt any maintenance or repair work not described in the instruction manual. Have all other work performed by a servicing dealer.

STIHL recommends that you have servicing and repair work carried out exclusively by an authorized STIHL servicing dealer. STIHL dealers are regularly given the opportunity to attend training courses and are supplied with the necessary technical information.

Only use high-quality replacement parts in order to avoid the risk of accidents and damage to the machine. If you have any questions in this respect, consult a servicing dealer.

STIHL recommends the use of genuine STIHL replacement parts. They are specifically designed to match your model and meet your performance requirements.

To reduce the risk of injury, **always shut off the engine** before carrying out any maintenance or repairs or cleaning the machine. – Exception: Carburetor and idle speed adjustments.

Do not turn the engine over on the starter with the spark plug boot or spark plug removed since there is otherwise a **risk of fire** from uncontained sparking.

Do not service or store your machine near open flames.

Check the fuel filler cap for leaks at regular intervals.

Use only a spark plug of the type approved by STIHL and make sure it is in good condition – see "Specifications".

Inspect the ignition lead (insulation in good condition, secure connection).

Check the condition of the muffler.

To reduce the **risk of fire and damage to hearing**, do not operate your machine if the muffler is damaged or missing.

Do not touch a hot muffler since **burn injury** will result.

Vibration behavior is influenced by the condition of the AV elements – check the AV elements at regular intervals.

Shut off the engine before rectifying problems.

3 Assembling the Unit

3.1 Mounting the Hose Clamps and Pleated Hose

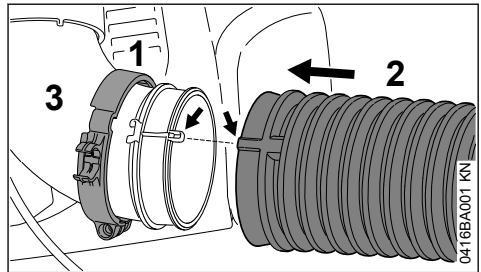

- ▶ Push the hose clamp (1) (with retainer for throttle cable) onto the elbow (3).
- ▶ Push the pleated hose (2) over the elbow (3).

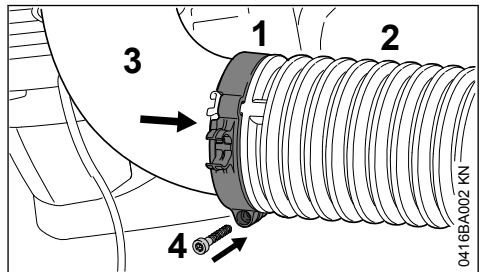

- ▶ Push the hose clamp (1) onto the pleated hose (2) – screw boss facing down.
- ▶ Secure the hose clamp (1) with the screw (4).

3.4.2 Removing the Nozzle

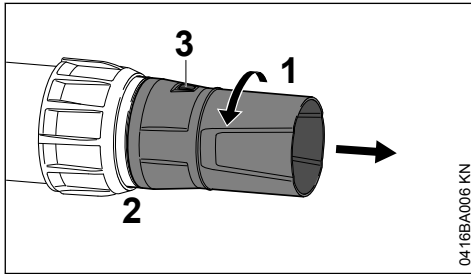

- ▶ Rotate the nozzle (1) in the direction of the arrow until the lugs (3) are covered.
- ▶ Pull the nozzle (1) off the blower tube (2).

3.5 Adjusting the Blower Tube

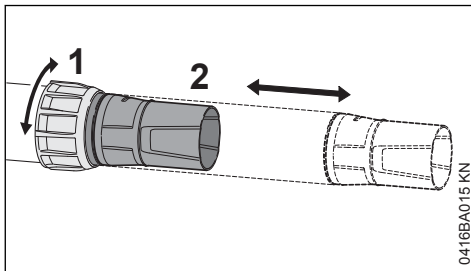

- ▶ Loosen the union nut (1).
- ▶ Pull the blower tube (2) out to the required length.
- ▶ Tighten the union nut (1).

3.6 Wear Mark on Nozzle

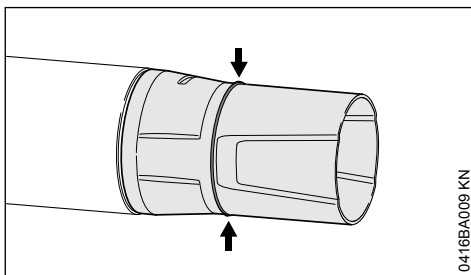

The front end of the nozzle wears away due to abrasive ground contact during operation. The nozzle is subject to normal wear and tear and must be replaced when the wear mark is reached.

3.7 Transport Aid

The blower tube can be hooked to the blower housing for storage and transport.

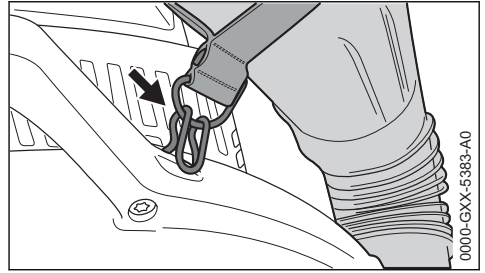

- ▶ Attach D-ring to the hook on the blower housing.

! WARNING

Air or dirt particles can be blown into the user's face and eyes if the engine is started while the blower tube is still on the hook.

- ▶ Unhook the blower tube before starting the engine.

NOTICE

If clothing or other objects are hung on the hook, the intake openings may be covered and cause the engine to overheat.

- ▶ Use the hook only for hanging up the blower tube for storage or transport.
- ▶ Do not hang clothing or other items on the hook.

4 Adjusting the Throttle Cable

It may be necessary to correct the adjustment of the throttle cable after assembling the machine or after a prolonged period of operation.

Adjust the throttle cable only when the unit is completely and properly assembled.

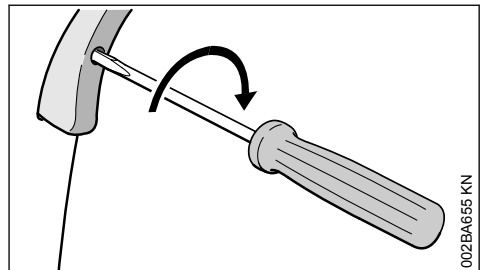

- ▶ Set the throttle trigger to the full throttle position.

- ▶ Carefully rotate the screw in the throttle trigger in the direction of the arrow until you feel initial resistance. Then rotate it another half turn in the same direction.

5 Fitting the Harness

5.1 Adjusting the Harness

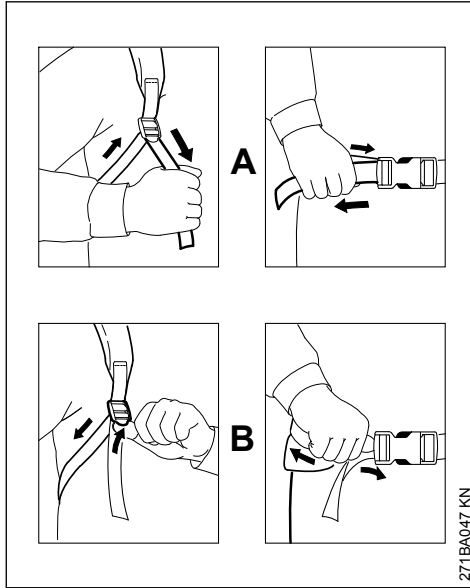

- A** Pull the straps to tighten the harness
- B** Lift the tabs of the adjusters to loosen the straps

271BA047 KN

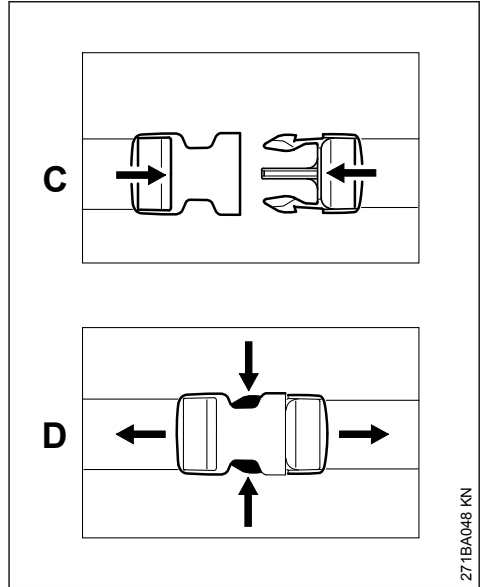

271BA048 KN

- C** Close the buckle by pushing the two parts together.
- D** Squeeze the hooks to open the buckle.

5.2 Fitting the harness

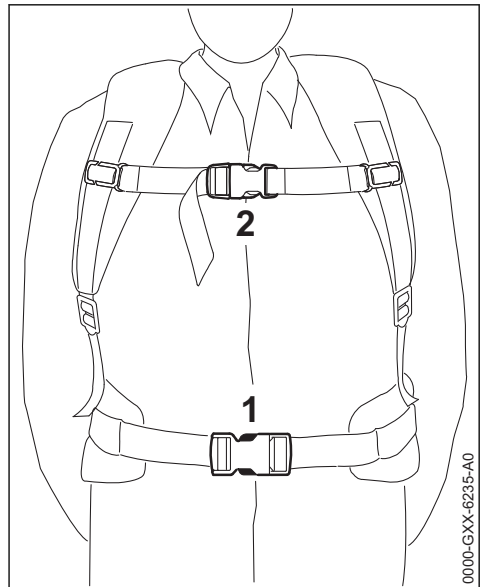

0000-GXX-623,5-A0

- ▶ Put the blower on your back.
- ▶ Close the buckle on the waist belt (1).

- ▶ Close the buckle on the chest strap (2).
- ▶ Tighten the straps until the waist belt fits snugly on your hips and the back padding is against your back.

5.3 Removing the Harness

- ▶ Loosen the straps.
- ▶ Open the buckles on the chest strap and waist belt.
- ▶ Take the blower off your back.

6 Fuel

The engine requires a mixture of gasoline and engine oil.



WARNING

Avoid direct skin contact with fuel and breathing in of gasoline fumes.

6.1 STIHL MotoMix

STIHL recommends using STIHL MotoMix. This pre-blended fuel is free of benzene and lead, is distinguished by a high octane rating, and always provides the proper mixing ratio.

STIHL MotoMix uses STIHL HP Ultra two-stroke engine oil for optimum engine life.

MotoMix is not available in all markets.

6.2 Mixing fuel

NOTICE

Unsuitable fuels or a mixing ratio that deviates from the specification can lead to severe engine damage. The engine, seals, fuel lines and fuel tank may be damaged if low-quality gasoline or engine oil is used.

6.2.1 Gasoline

Use only **high-quality gasoline** with an octane rating of at least 90 ROC – leaded or unleaded.

Gasoline with an alcohol component exceeding 10% can cause impaired engine performance in engines with manually adjustable carburetors and thus should not be used in these engines.

Engines with M-Tronic deliver full engine performance using gasoline with an alcohol component of up to 27% (E27).

6.2.2 Engine oil

If you mix the fuel yourself, use only STIHL two-stroke engine oil or another high-performance

engine oil classified as JASO FB, JASO FC, JASO FD, ISO-L-EGB, ISO-L-EGC or ISO-L-EGD.

STIHL specifies STIHL HP Ultra two-stroke engine oil or an equivalent high-performance engine oil in order to maintain emission limits over the machine's service life.

6.2.3 Mixing ratio

with STIHL two-stroke engine oil 1:50; 1:50 = 1 part oil + 50 parts gasoline

6.2.4 Examples

Quantity of gaso- line	STIHL two-stroke engine oil 1:50	
Liters	Liters	(ml)
1	0.02	(20)
5	0.10	(100)
10	0.20	(200)
15	0.30	(300)
20	0.40	(400)
25	0.50	(500)

- ▶ Pour oil into an approved safety fuel canister first, then add gasoline and mix thoroughly

6.3 Storing fuel mixture

Store in approved safety fuel canisters only in a dry, cool and secure place protected against light and sunlight.

Fuel mixture deteriorates with age – mix only as much as needed for a few weeks. Do not store fuel mixture for longer than 30 days. The fuel mixture can become unusable more quickly if exposed to light, sunlight or low or high temperatures.

STIHL MotoMix however can be stored for up to 5 years without any problems.

- ▶ Shake the canister containing the fuel mixture thoroughly before refueling



WARNING

Pressure may have built up in the canister – open it carefully.

- ▶ The fuel tank and the canister in which fuel mixture is stored should be cleaned thoroughly from time to time

Residual fuel and the liquid used for cleaning must be disposed of in accordance with regulations and without harming the environment!

7 Fueling



7.1 Preparations

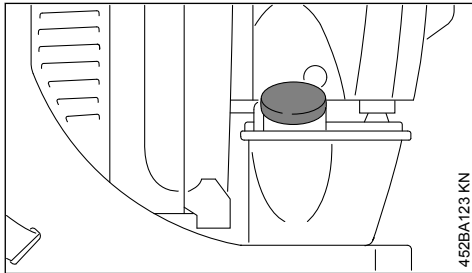

452BA123 KN

- ▶ Before fueling, clean the filler cap and the area around it to ensure that no dirt falls into the tank.

7.2 Opening screw-type tank cap

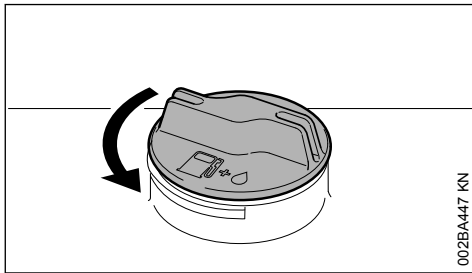

002BA447 KN

- ▶ Turn the cap counterclockwise until it can be removed from the tank opening.
- ▶ Remove the cap.

7.3 Filling up with fuel

Take care not to spill fuel while fueling and do not overfill the tank. STIHL recommends you use the STIHL filler nozzle (special accessory).

7.4 Closing screw-type tank cap

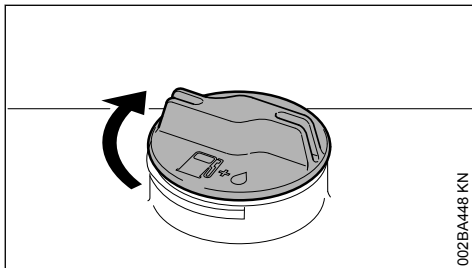

002BA448 KN

- ▶ Place the cap in the opening.

- ▶ Turn the cap clockwise as far as stop and tighten it down as firmly as possible by hand.

8 Winter Operation



8.1 At temperatures below +10°C

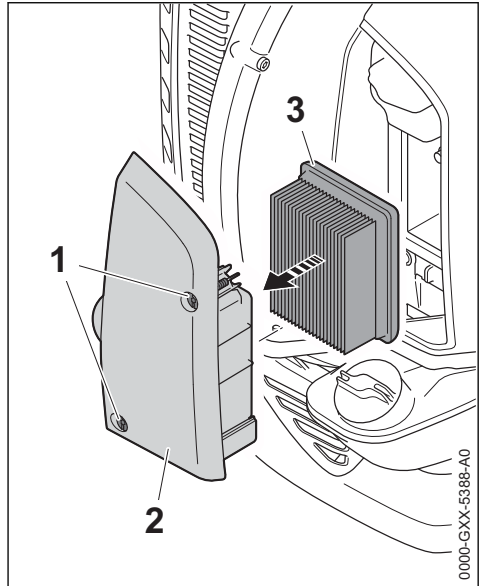

0000-GXX-5388-A0

- ▶ Loosen the screws (1).
- ▶ Remove the filter cover (2) together with the air filter (3).

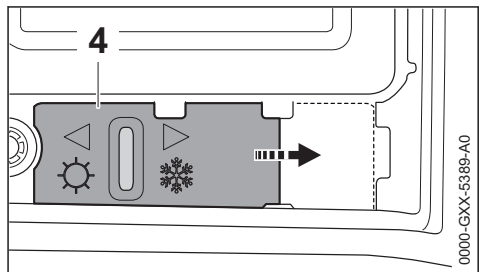

0000-GXX-5389-A0

- ▶ Move the shutter (4) to the right to position ❄️ (winter operation).
- ▶ Fit the filter cover (2) with air filter (3) in position.
- ▶ Insert the screws (1) and tighten them down firmly.

8.2 At temperatures above +20°C

- Move the shutter (4) to the left to position ☀ (summer operation).

NOTICE

If the shutter (4) is not moved to position ☀ at temperatures above 20°C, there is a risk of engine running problems caused by overheating.

9 Information Before You Start

NOTICE

With the engine stopped, check the following parts before starting and clean if necessary:

- Base plate
- Intake screen between backplate and engine

9.1 Positions of Setting Lever

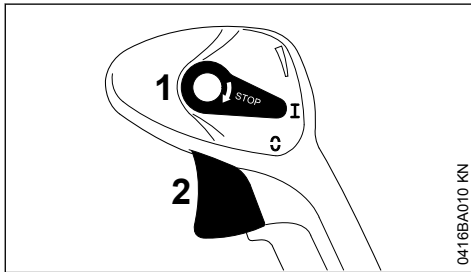

0416BA010 KN

- 1 Setting lever
- 2 Throttle trigger

Position "I"

Engine runs or is ready to start. Throttle trigger (2) can be moved to any position.

Position "☀"

Ignition is interrupted, engine stops. The setting lever (1) is not locked in this position. It springs back to position "I". The ignition is switched on again.

Fixed throttle

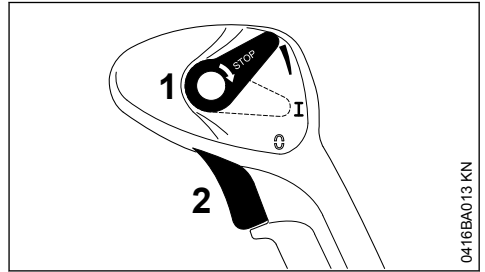

0416BA013 KN

The throttle trigger (2) can be locked in any position.

To disengage the lock:

- Return the setting lever (1) to position "I".

10 Starting / Stopping the Engine

10.1 Starting the Engine

- Observe safety precautions.

NOTICE

Start your machine on a clean, dust-free surface only to ensure that no dust is sucked in.

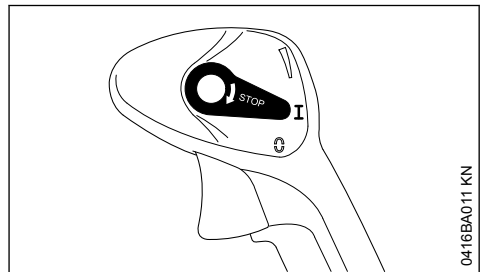

0416BA011 KN

- Move the setting lever to I

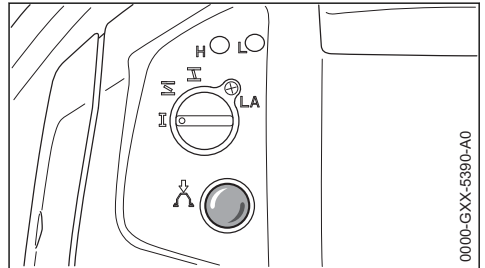

0000-GXX-5390-A0

- Press the fuel pump bulb at least 6 times – even if the bulb is already filled with fuel.

10.1.1 Cold engine (cold start)

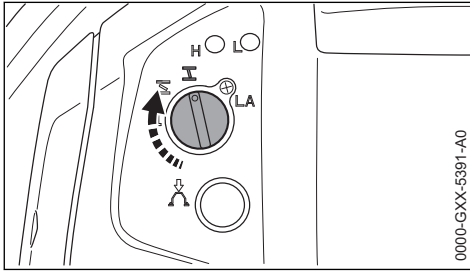

0000-GXX-5391-A0

- ▶ Turn the choke knob to **I**.

10.1.2 Warm engine (warm start)

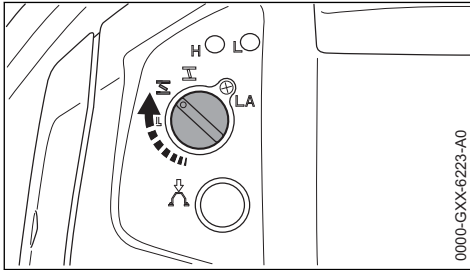

0000-GXX-6223-A0

- ▶ Turn the choke knob to **LA**.

Also use this setting if the engine has been running but is still cold.

10.1.3 Cranking



0000-GXX-5394-A0

- ▶ Place the machine securely on the ground – make sure that bystanders are well clear of the nozzle outlet and
- ▶ take the blower tube off the hook on the blower housing (transport position).
- ▶ Make sure you have a firm footing: Hold the machine with your left hand on the housing and put one foot against the base plate to prevent it slipping.
- ▶ Pull the starter grip steadily and quickly with your right hand. Do not pull out the starter rope to full length – **it might otherwise break.**
- ▶ Do not let the starter grip snap back. Guide it slowly back into the housing so that the starter rope can rewind properly.
- ▶ Continue cranking until the engine fires.

10.1.4 When Engine Begins to Fire

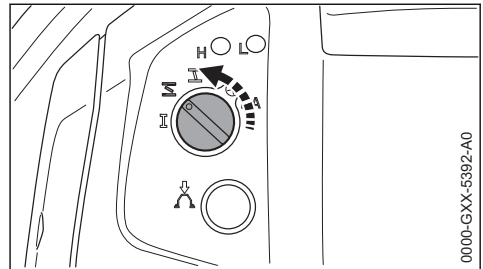

0000-GXX-5392-A0

If the engine is **cold**:

- ▶ Turn the choke knob to **LA** and continue cranking until the engine runs.

If the engine is **warm**:

- ▶ Continue cranking until the engine runs.

10.2 As Soon As the Engine Runs

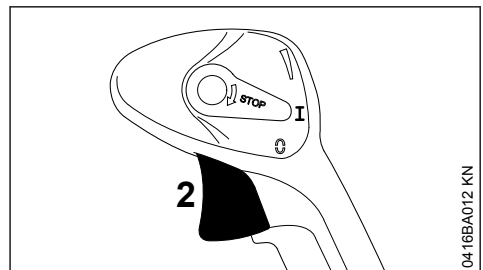

0416BA012 KN

- ▶ Blip the throttle trigger (2) – the choke knob automatically returns to **I**

or

- ▶ Turn the choke knob to **I**.

The engine settles down to idling speed.

10.2.1 At very low outside temperatures

- ▶ Allow engine to run in the cold start position **I** until it almost stalls.
- ▶ If the engine stalls in the cold start position **I**, turn the choke knob to **II** and restart the engine.

10.3 Stopping the Engine

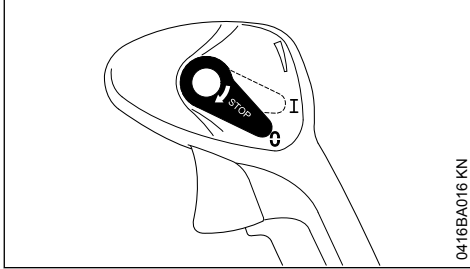

0416BA016 KN

- ▶ Push the setting lever in the direction of **0** – the engine stops – the setting lever then springs back automatically.

10.4 After Short Work Breaks

If the blower was running and the engine shut down, it can be restarted on your back after short work breaks.



0000-GXX-5395-A0

- ▶ Machine is on your back – make sure that bystanders are well clear of the nozzle outlet.
- ▶ Make sure you have a safe and secure footing.

- ▶ Hold blower tube with your right hand on the control handle.
- ▶ Pull the starter grip steadily and quickly with your left hand. Do not pull out the starter rope to full length – **it might otherwise break.**
- ▶ Do not let the starter grip snap back. Guide it slowly back into the housing so that the starter rope can rewind properly.
- ▶ Continue cranking until the engine runs.

10.5 If Engine Does Not Start

10.5.1 Choke Knob

If you did not turn the choke knob to **II** quickly enough after the engine began to fire, the combustion chamber is flooded.

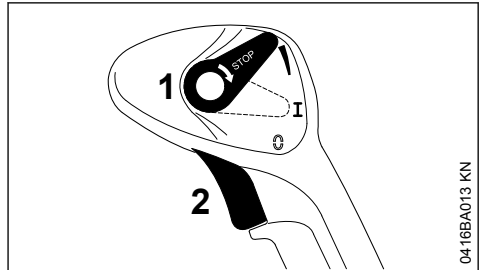

0416BA013 KN

- ▶ Push the setting lever (1) upwards. The throttle trigger (2) is in the full throttle position.
- ▶ Continue cranking until the engine runs.

10.5.2 Other Hints on Starting

If the engine does not start

- ▶ Check that all settings are correct.
- ▶ Check that there is fuel in the tank and refuel if necessary.
- ▶ Check that the spark plug boot is properly connected.
- ▶ Repeat the starting procedure.
- ▶ Check adjustment of throttle cable – see chapter on "Adjusting the Throttle Cable".

Engine stalls in cold start position **I** or under acceleration

- ▶ Turn the choke knob to **II** and continue cranking until the engine runs.

Engine does not start in warm start position **II**

- ▶ Move the choke knob to **I** and continue cranking until the engine runs.

Fuel tank run until completely dry

- ▶ After refueling, depress the manual fuel pump bulb at least 6 times – even if the bulb is already filled with fuel.

- ▶ Set the choke knob according to engine temperature.
- ▶ Start the engine.

11 Operating Instructions

11.1 During Operation

After a long period of full throttle operation, allow the engine to run for a short while at idle speed so that engine heat can be dissipated by the flow of cooling air. This helps protect engine-mounted components (ignition, carburetor) from thermal overload.

11.2 After Finishing Work

Storing for a short period: Wait for the engine to cool down. Keep the machine in a dry place, well away from sources of ignition, until you need it again. For longer out-of-service periods – see "Storing the Machine".

12 Replacing the Air Filter

Dirty air filters reduce engine power, increase fuel consumption and make starting more difficult.

12.1 If There is a Noticeable Loss of Engine Power

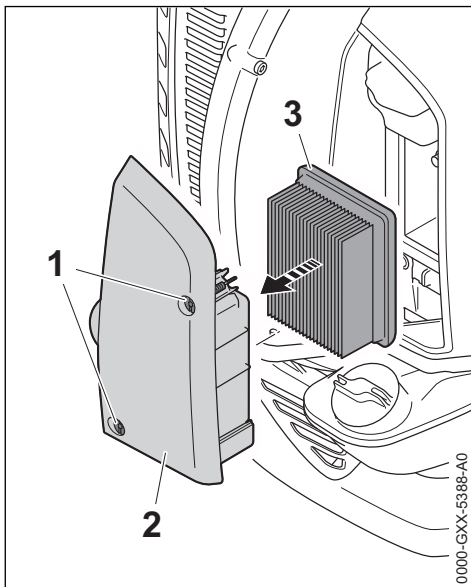

- ▶ Loosen the screws (1).
- ▶ Remove the filter cover (2) together with the air filter (3).

- ▶ Remove the air filter (3) from the filter cover.
- ▶ Replace a dirty or damaged air filter (3).
- ▶ Fit the new air filter (3) in the filter cover (2).
- ▶ Fit the filter cover (2) with air filter (3) in position.
- ▶ Insert the screws (1) and tighten them down firmly.

13 Adjusting the Carburetor

13.1 Adjusting Idle Speed

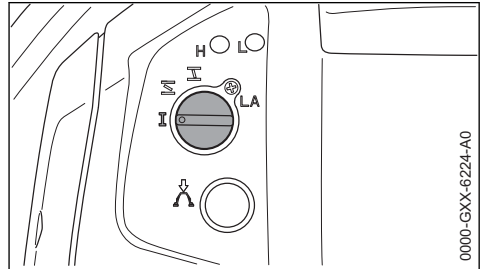

Engine stops while idling:

- ▶ Turn the idle speed screw (LA) slowly clockwise until the engine runs smoothly.

14 Spark Plug

- ▶ If the engine is down on power, difficult to start or runs poorly at idle speed, first check the spark plug.
- ▶ Fit a new spark plug after about 100 operating hours – or sooner if the electrodes are badly eroded. Install only suppressed spark plugs of the type approved by STIHL – see "Specifications".

14.1 Removing the Spark Plug

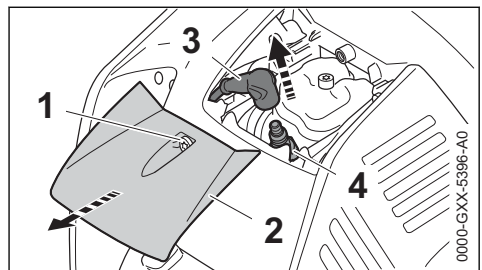

- ▶ Loosen the screw (1).
- ▶ Remove the cover (2).
- ▶ Pull off the spark plug boot (3).
- ▶ Unscrew the spark plug (4).

14.2 Checking the Spark Plug

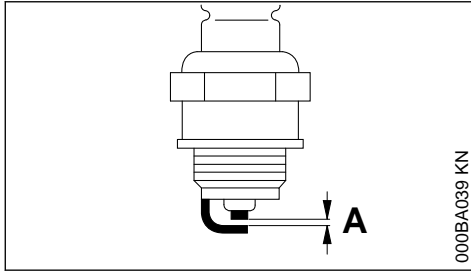

000BA039 KN

- ▶ Clean dirty spark plug.
- ▶ Check electrode gap (A) and readjust if necessary – see "Specifications".
- ▶ Rectify the problems which have caused fouling of the spark plug.

Possible causes are:

- Too much oil in fuel mix.
- Dirty air filter.
- Unfavorable running conditions.

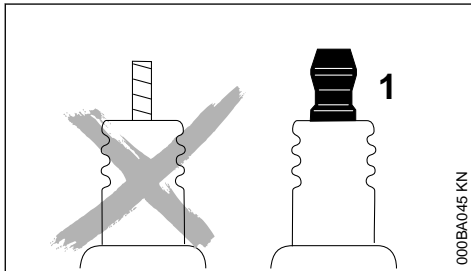

000BA045 KN

! WARNING

Arcing may occur if the adapter nut (1) is loose or missing. Working in an easily combustible or explosive atmosphere may cause a fire or an explosion. This can result in serious injuries or damage to property.

- ▶ Use resistor type spark plugs with a properly tightened adapter nut.

14.3 Installing the Spark Plug

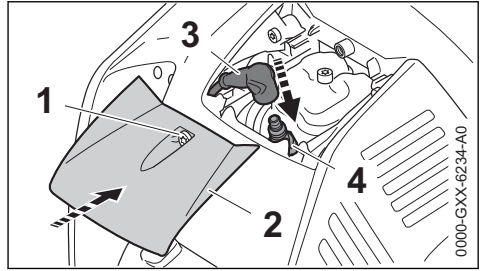

0000-GXX-6234-A0

- ▶ Screw the spark plug (4) into the cylinder and fit the boot (3) (press it down firmly).
- ▶ Fit the cover (2).
- ▶ Insert and tighten down the screw (1).

NOTICE

If the blower is operated without the cover (2), the engine may overheat and this can result in engine damage.

- ▶ Operate your blower only with the cover fitted in position.

15 Spark Arresting Screen in Muffler

! WARNING

To reduce the risk of fire caused by hot particles escaping from the machine, never operate the machine without a spark arresting screen, or with the spark arresting screen damaged. Do not modify the muffler or spark arresting screen.

NOTICE

According to the law or regulations in some countries or federal states, certain operations may only be carried out if a properly serviced spark arresting screen is provided.

- ▶ If the engine is down on power, check the spark arresting screen in the muffler
- ▶ Wait for the muffler to cool down

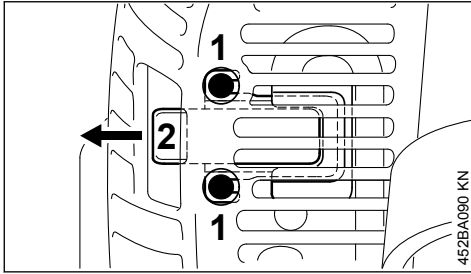

- ▶ Undo the screws (1)
- ▶ Remove the scoop □(2)
- ▶ Remove the spark arresting screen
- ▶ Clean the spark arresting screen. If the screen is damaged or heavily carbonized, fit a new one

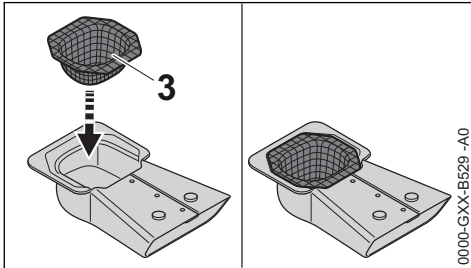

- ▶ Refit the spark arresting screen (3)
- ▶ Fit the scoop

16 Storing the Machine

If out of use for periods of about 30 days or longer

- ▶ Drain and clean the fuel tank in a well ventilated area.
- ▶ Dispose of fuel properly in accordance with local environmental requirements.

18 Maintenance and Care

The following intervals apply for normal operating conditions. The specified intervals must be shortened accordingly when working for longer than normal or under difficult cutting conditions (extensive dust, etc.).

	Before starting work	At the end of work and/or daily	Whenever tank is refilled	Weekly	Monthly	Annually	If faulty	If damaged	As required
Complete machine	X		X						
Visual inspection (condition, leaks)	X		X						

- ▶ If a manual fuel pump is fitted: Press the manual fuel pump at least 5 times.
- ▶ Start the engine and run it at idling speed until it stops
- ▶ Thoroughly clean the machine, especially the cylinder fins and air filter
- ▶ Store the machine in a dry and safe location. Keep out of the reach of children and other unauthorized persons

16.1 Hanging up the Blower

The hole (arrow) in the backplate can be used to hang up the blower.

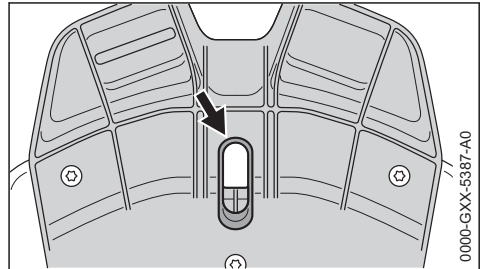

17 Inspections and Maintenance by Dealer

17.1 Fuel pickup body in tank

- ▶ Have the pickup body in the fuel tank replaced every year.

STIHL recommends that you have servicing and repair work carried out exclusively by an authorized STIHL servicing dealer.

The following intervals apply for normal operating conditions. The specified intervals must be shortened accordingly when working for longer than normal or under difficult cutting conditions (extensive dust, etc.).		Before starting work	At the end of work and/or daily	Whenever tank is refilled	Weekly	Monthly	Annually	If faulty	If damaged	As required
	Clean		X							
Control handle	Function test	X		X						
Air filter	replace							X	X	
Manual fuel pump	check	X								
	Have repaired by a specialist dealer ¹⁾								X	
Filter in fuel tank	Have checked by dealer ¹⁾							X		
	Have replaced by servicing dealer ¹⁾						X			X
Fuel tank	Clean					X				
Carburetor	Check idle speed	X		X						
	Readjust idle speed									X
Spark plug	Adjust electrode gap							X		
	Replace after every 100 hours of operation									
Intake port for cooling air	Visual inspection		X							
	Clean				X					
Valve clearance	If power is low or cranking effort very high, have valve clearance checked and, if necessary, adjusted by dealer ¹⁾									X
Spark arresting screen in muffler	Check if installed	X								
	Check or replace ¹⁾						X			
Spacer, shim	check	X								
	Have replaced by servicing dealer ¹⁾	X						X		
All accessible screws, nuts and bolts (not adjusting screws)	Tighten									X
Anti-vibration elements	check	X								
	Have replaced by servicing dealer ¹⁾							X	X	
Blower air intake shield	check	X		X						
	Clean									X
Base plate	check	X		X						
	Clean									X

The following intervals apply for normal operating conditions. The specified intervals must be shortened accordingly when working for longer than normal or under difficult cutting conditions (extensive dust, etc.).		Before starting work	At the end of work and/or daily	Whenever tank is refilled	Weekly	Monthly	Annually	If faulty	If damaged	As required
Throttle cable	set									X
Safety information label	replace							X		
1)STIHL recommends STIHL dealers										

19 Main Parts

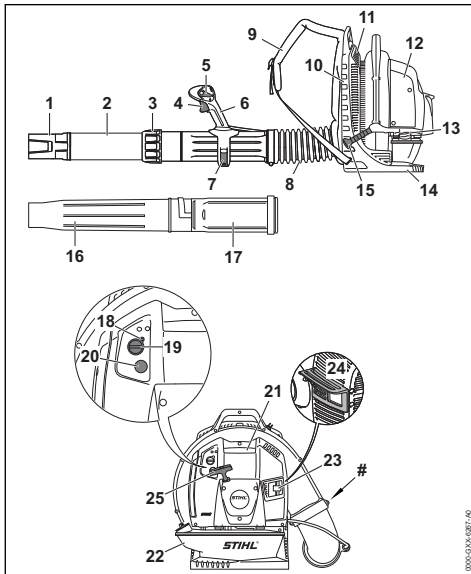

- 1 Nozzle
- 2 Blower Tube
- 3 Union Nut
- 4 Throttle Trigger
- 5 Setting Lever
- 6 Control Handle
- 7 Clamping Lever
- 8 Pleated Hose
- 9 Harness
- 10 Backplate
- 11 Intake Screen

- 12 Air Filter
- 13 Tank Cap
- 14 Base Plate
- 15 Starter Grip
- 16 Nozzle (BR 800 X)
- 17 Blower Tube (BR 800 X)
- 18 Idle Speed Screw (LA)
- 19 Choke Knob
- 20 Manual Fuel Pump
- 21 Spark Plug Boot
- 22 Fuel Tank
- 23 Muffler with Spark Arresting Screen
- 24 Spacer
- 25 Starter Grip (BR 800 X)
- # Serial Number

20 Specifications

20.1 Engine

STIHL 4-MIX Engine

Displacement:	79.9cm ³
Cylinder bore:	50 mm
Piston stroke:	40.7 mm
Idle speed:	2500 rpm

20.2 Ignition system

Electronic magneto ignition

Spark plug (suppressed):	NGK CMR 6 H, BOSCH USR 4AC
Electrode gap:	0.5 mm

20.3 Fuel system

All-position diaphragm carburetor with integral fuel pump

Fuel tank capacity: 2000 cm³ (2.0 l)

20.4 Blowing capacity

Blowing force:	41 N
Air velocity	89 m/s
Air throughput:	1550 m ³ /h
Maximum air speed:	107 m/s
Maximum air flow rate without blower tube:	2025 m ³ /h

20.5 Weight

Without fuel: 11.7 kg

20.6 Noise and Vibration Data

For further details on compliance with Vibration Directive 2002/44/EC see www.stihl.com/vib.

20.7 Sound pressure level L_p to DIN EN 15503

106 dB(A)

20.8 Sound power level L_w to DIN EN 15503

114 dB(A)

20.9 Vibration level a_{hv,eq} to DIN EN 15503

20.9.1 Standard version

	Handle, right
BR 800:	3.5 m/s ²

20.9.2 Version with bike handle

	Handle, left	Handle, right
BR 800:	2.9 m/s ²	2.3 m/s ²

The K-factor in accordance with Directive 2006/42/EC is 2.0 dB(A) for the sound pressure level and sound power level; the K-factor in accordance with Directive 2006/42/EC is 2.0 m/s² for the vibration level.

20.10 REACH

REACH is an EC regulation and stands for the Registration, Evaluation, Authorization and Restriction of Chemical substances.

For information on compliance with the REACH regulation (EC) No. 1907/2006 see

www.stihl.com/reach

20.11 Exhaust Emissions

The CO₂ value measured in the EU type approval procedure is specified at

www.stihl.com/co2

in the product-specific technical data.

The measured CO₂ value was determined on a representative engine in accordance with a standardized test procedure under laboratory conditions and does not represent either an explicit or implied guarantee of the performance of a specific engine.

The applicable exhaust emission requirements are fulfilled by the intended usage and maintenance described in this User Manual. The operating license shall be void if the engine is modified in any way.

21 Maintenance and Repairs

Users of this machine may only carry out the maintenance and service work described in this user manual. All other repairs must be carried out by a servicing dealer.

STIHL recommends that you have servicing and repair work carried out exclusively by an authorized STIHL servicing dealer. STIHL dealers are regularly given the opportunity to attend training courses and are supplied with the necessary technical information.

When repairing the machine, only use replacement parts which have been approved by STIHL for this power tool or are technically identical. Only use high-quality replacement parts in order to avoid the risk of accidents and damage to the machine.

STIHL recommends the use of original STIHL replacement parts.

Original STIHL parts can be identified by the STIHL part number, the **STIHL** logo and the STIHL parts symbol **SI** (the symbol may appear alone on small parts).

22 Disposal

Contact the local authorities or your STIHL servicing dealer for information on disposal.

Improper disposal can be harmful to health and pollute the environment.

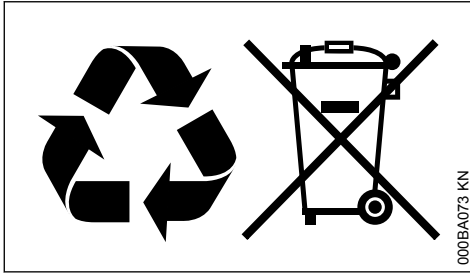

- ▶ Take STIHL products including packaging to a suitable collection point for recycling in accordance with local regulations.
- ▶ Do not dispose with domestic waste.

23 EC Declaration of Conformity

ANDREAS STIHL AG & Co. KG
Badstr. 115
D-71336 Waiblingen

Germany

declare under our sole responsibility that

Designation:	Blower
Make:	STIHL
Series:	BR 800
	BR 800 C
Serial identification number:	4283
Displacement:	79.9 cm ³

conforms to the relevant provisions of Directives 2011/65/EU, 2006/42/EC, 2014/30/EU and 2000/14/EC and has been developed and manufactured in compliance with the following standards in the versions valid on the date of production:

EN ISO 12100, EN 15503, EN 55012,
EN 61000-6-1

The measured and the guaranteed sound power level have been determined in accordance with Directive 2000/14/EC, Annex V, and standard ISO 11094.

Measured sound power level

112 dB(A)

Guaranteed sound power level

114 dB(A)

Technical documents deposited at:

ANDREAS STIHL AG & Co. KG
Produktzulassung

The year of manufacture and serial number are applied to the product.

Done at Waiblingen, 03.02.2020

ANDREAS STIHL AG & Co. KG

pp

Dr. Jürgen Hoffmann

Director Product Certification & Regulatory Affairs



www.stihl.com



0458-490-8321-B



0458-490-8321-B